

# Triple Power Parallel Box User Manual



## SolaX Power Network Technology (Zhejiang) Co., Ltd.

Add.: No. 288 Shizhu Road, Tonglu Economic Development Zone, Tonglu City, Zhejiang Province, China 311500  
Tel.: +86 571-56260011  
E-mail: info@solaxpower.com

614.00505.04

Copyright © SolaX Power Technology (Zhejiang) Co., Ltd. All rights reserved.  
No part of this document may be reproduced or transmitted in any form or by any means without prior written consent of SolaX Power Technology (Zhejiang) Co., Ltd. (hereinafter referred to as SolaX). SolaX reserves the right of final interpretation.

[www.solaxpower.com](http://www.solaxpower.com)

# Contents

1	NOTE ON THIS MANUAL .....	1
1.1	SCOPE OF VALIDITY .....	1
1.2	TARGET GROUP .....	1
1.3	SYMBOLS USED .....	1
2	SAFETY .....	2
2.1	APPROPRIATE USAGE .....	2
2.2	IMPORTANT SAFETY INSTRUCTIONS .....	3
2.3	QUALIFIED INSTALLER .....	4
3	PRODUCTION INTRODUCTION .....	6
3.1	PRODUCTION OVERVIEW .....	6
3.1.1	DIMENSIONS .....	6
3.1.2	APPEARANCE .....	7
3.2	BASIC FEATURES .....	8
3.2.1	FEATURES .....	8
3.2.2	CERTIFICATIONS .....	8
3.3	TECHNICAL DATA .....	9
4	INSTALLATION .....	10
4.1	INSTALLATION PREREQUISITES .....	10
4.2	SAFETY GEAR .....	10
4.3	TOOLS .....	11
4.4	INSTALLATION .....	11
4.4.1	CHECK FOR TRANSPORT DAMAGE .....	11
4.4.2	UNPACKING .....	11
4.4.3	ACCESSORIES .....	12
4.4.4	MOUNTING STEPS .....	12
4.5	OVERALL INSTALLATION .....	14
4.6	CABLE CONNECTION .....	16
4.6.1	CONNECTING CABLES TO INVERTER .....	16
4.6.2	CONNECTING BATTERY MODULES .....	18
4.6.3	CONNECTING RS485 COMMUNICATION CABLE .....	20
5	COMMISSIONING .....	21
5.1	CONFIGURING BATTERY SYSTEM .....	21
5.2	COMMISSIONING .....	22

5.3 STATUS INDICATORS .....	23
5.4 SHUTTING DOWN THE BOX.....	23
6 TROUBLESHOOTING .....	24
7 DECOMMISSIONING.....	26
7.1 DISMANTLING THE BOX.....	26
7.2 PACKAGING.....	26
8 MAINTENANCE .....	27
9 WARRANTY .....	28
* WARRANTY REGISTRATION FORM	

## 1 Note on this Manual

### 1.1 Scope of Validity

This manual is an integral part of the Parallel Box Series. It describes the assembly, installation, commissioning, maintenance and failure of the product. Read carefully prior to operation.

Model: BMS Parallel Box-II

Note: The parallel box can be used with battery module(s).

Refer to section 3.3 BMS Parallel Box-II Configuration List on page 9 for details.

### 1.2 Target Group

This manual is for qualified electricians. The tasks described in this manual may only be performed by qualified electricians.

### 1.3 Symbols Used

The following types of safety instructions appear in this document and are described below:



#### DANGER!

“DANGER” indicates a hazardous situation which, if not avoided, will result in serious injury or death.



#### WARNING!

“WARNING” indicates a hazardous situation which, if not avoided, could result in serious injury or death.



#### CAUTION!

“CAUTION” indicates a hazardous situation which, if not avoided, could result in minor or moderate injury.



#### NOTE!

“NOTE” provides tips that are valuable for the optimal operation of your product.

## 2 Safety

### 2.1 Appropriate Usage

For safety reasons, installers are responsible for familiarizing themselves with the contents of this manual and all warnings before performing installation.

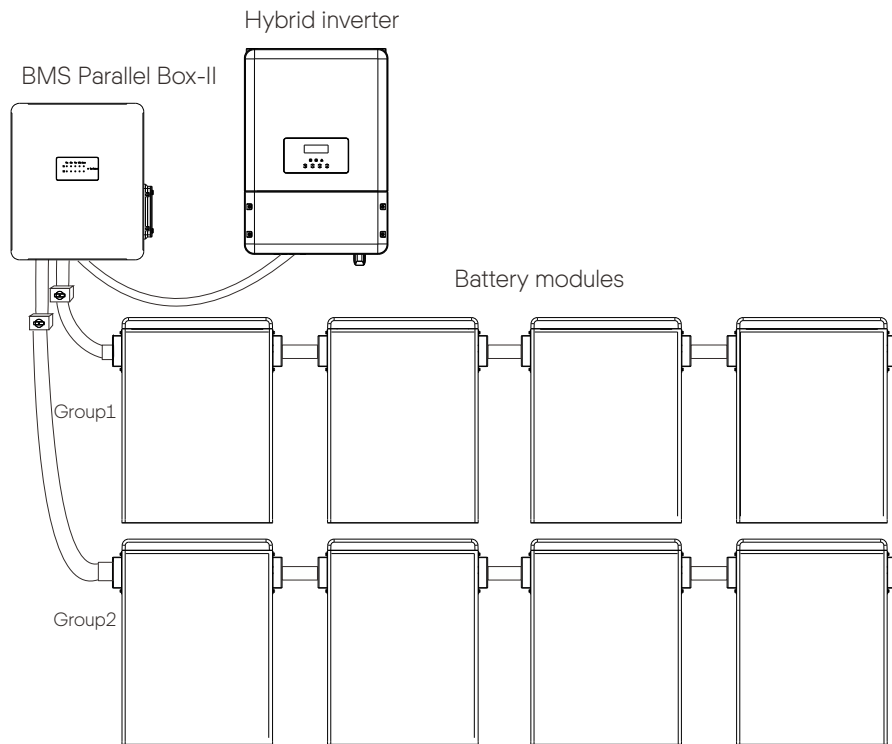

### 2.2 Important Safety Instructions

#### DANGER!

Danger to life due to high voltages in the inverter!

- All work must be carried out by qualified electrician.
- The appliance is not to be used by children or persons with reduced physical sensory or mental capabilities, or lack of experience and knowledge, unless they have been given supervision or instruction.
- Children should be supervised to ensure that they do not play with the appliance.



#### CAUTION!

Danger of burn injuries due to hot enclosure parts!

- During operation, the upper lid of the enclosure and the enclosure body may become hot.
- Only touch the lower enclosure lid during operation.



#### CAUTION!

Possible damage to health as a result of the effects of radiation!

- Do not stay closer than 0.66 ft/20 cm to inverter for any length of time.



#### WARNING!

Do not operate the inverter when the device is running.



#### WARNING!

Risk of electric shock!



#### WARNING!

Authorized service personnel must disconnect the cables before attempting any maintenance or cleaning or working on any circuits connected to the box.



Prior to the application, please read this section carefully to ensure correct and safe application. Please keep the user manual properly.

Use only attachments recommended or sold by SolaX. Otherwise may result in a risk of fire, electric shock, or injury to person.

Make sure that existing wiring is in good condition and that wire is not undersized.

Do not disassemble any parts of the box which are not mentioned in installation guide. It contains no user-serviceable parts. See Warranty for instructions on obtaining service. Attempting to service the box yourself may result in a risk of electric shock or fire and will void your warranty.

Keep away from flammable, explosive materials to avoid fire disaster.

The installation place should be away from humid or corrosive substance.

Authorized service personnel must use insulated tools when installing or working with this equipment.

## 2.3 Qualified Installer



### WARNING!









All operations of box relating to electrical connection and installation must be carried out by qualified personnel.

A skilled worker is defined as a trained and qualified electrician or installer who has all of the following skills and experience:

- Knowledge of the functional principles and operation of grid-tied systems
- Knowledge of the dangers and risks associated with installing and using electrical devices and acceptable mitigation methods
- Knowledge of the installation of electrical devices
- Knowledge of and adherence to this manual and all safety precautions and best practices

## Explanation of Symbols

This section gives an explanation of all the symbols shown on the warning label.

Symbol	Explanation
	The system must be disposed of at a proper facility for environmentally-safe recycling.
	The system should not be disposed of together with household waste. Disposal information can be found in the enclosed documentation.
	Wear protective glasses.
	Observe enclosed documentation.
	Keep the battery system away from open flames or ignition sources.
	Keep the battery system away from children.
	Danger of high voltages.
	Danger. Risk of electric shock.

## 3 Product Introduction

### 3.1 Product Overview

For safety reasons, installers are responsible for familiarizing themselves with the contents of this manual and all warnings before performing installation.

#### 3.1.1 Dimension

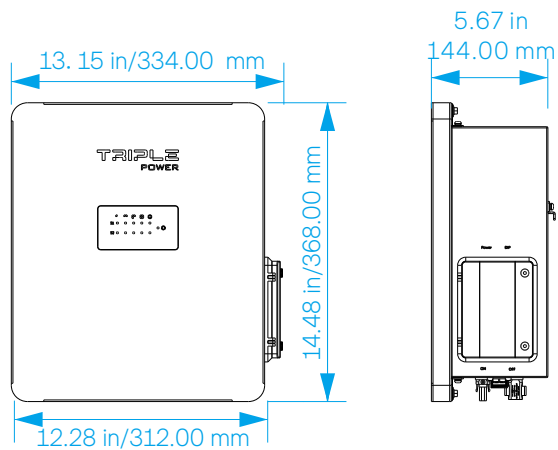

#### 3.1.2 Appearance

- Terminals of the BMS Parallel Box-II

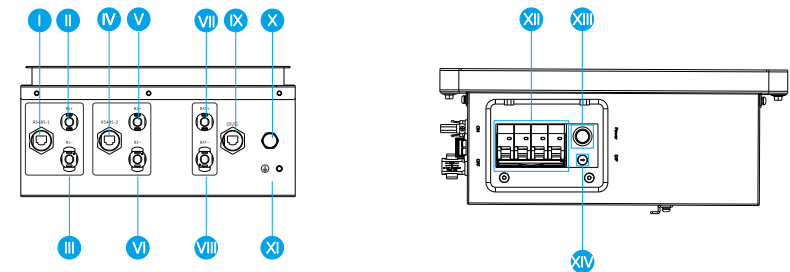

Object	Mark	Description
I	RS485-1	Battery module communication of group 1
II	B1+	Connector B1+ of Box to + of battery module of group 1
III	B1-	Connector B1- of Box to - of battery module of group 1
IV	RS485-2	Battery module communication of group 2
V	B2+	Connector B2+ of Box to + of battery module of group 2
VI	B2-	Connector B2- of Box to - of battery module of group 2
VII	BAT+	Connector BAT+ of Box to BAT+ of inverter
VIII	BAT-	Connector BAT- of Box to BAT- of inverter
IX	BMS	Connector BMS of Box to BMS of inverter
X	/	Air Valve
XI	⊕	GND
XII	ON/OFF	Circuit Breaker
XIII	POWER	Power Button
XIV	DIP	DIP Switch



#### Note

The serial number of B1 and B2 slave batteries must be equal.

## 3.2 Basic Features

### 3.2.1 Features

The box is one of the most advanced energy storage systems on the market today, incorporating state-of-the-art technology, high reliability, and convenient control features shown as below:

- Interact with inverter
- According to the interactive information, judge and control the running state of the battery system
- BMS related control processing,
- Realize the corresponding fault identification and processing
- Ensure the safe operation of the battery system.
- Secondary Protection by Hardware
- IP55 Protection Level
- Safety & Reliability
- Small Occupied Area
- Wall Mounting

### 3.2.2 Certifications

Safety	IEC 62477-1, IEC 61439-1, IEC 61439-2
EMC	IEC 61000-6-1/2/3/4

## 3.3 Technical Data

Model	BMS Parallel Box-II
Dimension (W/H/D)(in/mm)	14.48*13.15*5.67/368*334*144
Dimension of Packing (W/H/D)(in/mm)	17.32*15.63*10.12/440*397*257
Net Weight (lbs/kg)	11.46/5.2
Input/Output voltage Range (V)	70-550
Maximum Charge/Discharge Current (A)	35
Environment	Outdoor
Standard Power (kW)	11.6
Maximum Power (kW)	14
Altitude (ft/m)	≤ 6561.68/2000
Pollution Degree	PD 3
Noise Level	<30dB
Overvoltage Category (OVC)	II
Protective Class	I
Operating Temperature	32°F~131°F/0°C~55°C
Ingress Protection	IP55

## 4 Installation

### 4.1 Installation Prerequisites

When assembling the system, avoid touching the terminal with any metal objects or bare hands. The box provides a safe source of electrical energy when operated as designed.

The previous safety precautions and the warning messages described in this section must be observed. If any of the previous precautions are not fully understood, or if you have any questions, contact customer service for guidance. The Safety Section may not include all regulations for your region.

Ensure that the installation location meets the following conditions:

- The building is designed to withstand earthquakes
- The location is far from the sea to avoid salt water and humidity, over 0.62 miles/997.79 meters
- The floor is flat and level
- There are no flammable or explosive materials, at a minimum of 3 ft/0.91 m
- The ambience is shady and cool, away from heat and direct sunlight
- The temperature and humidity remain at a constant level
- There is minimal dust and dirt in the area
- There are no corrosive gases present, including ammonia and acid vapor

In practice, the requirements of box installation may be different due to environment and locations.

In that case, follow up the exact requirements of the local laws and standards.



#### NOTE!

When installing the battery for the first time, the manufacturing date between battery modules should not exceed 3 months.

### 4.2 Safety Gear

Installation and maintenance personnel must operate according to applicable federal, state, and local regulations as well as industry standards regarding product installation. Personnel must wear safety gear as indicated below in order to avoid short circuit and personal injury.



Insulated Gloves



Safety Goggles



Safety Shoes

### 4.3 Tools

These tools are required to install the box.



Torque Screw Driver



Phillips-Screw Driver



Hexagon Wrench



Phillips-Head Screw Driver



Flat-Head Screw Driver



Torque Wrench

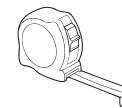

Tape Measure



Drill



Pencil or Marker

### 4.4 Installation

#### 4.4.1 Check for Transport Damage

Ensure the box is intact during and after transportation. If there are visible damages such as cracks, contact your dealer immediately.

#### 4.4.2 Unpacking

Unpack the box package by removing the packing tape. Ensure the box modules and relevant items are complete. See the package items on section 4.4.3 and check the packing list carefully. If any items are missing, immediately contact SolaX or your distributor directly.



#### CAUTION!

According to regional regulations, several people may be required for moving the equipment.



#### WARNING!

Strictly follow the installation steps. SolaX will not be responsible for any injuries or loss incurred by incorrect assembly and operation.



4.4.3 Accessories

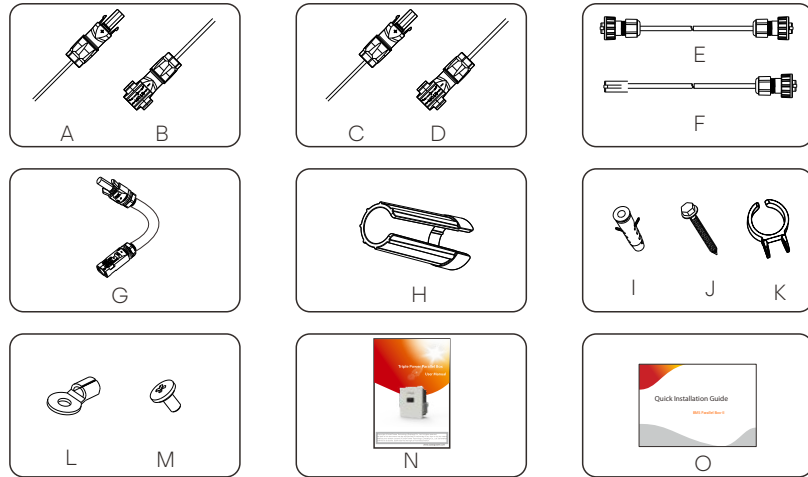

The table below lists the number of each component.

Object	Description	Quantity
A	Charging Cable (+) between Box and Inverter (6.56 ft/200.00 cm)	1
B	Charging Cable (-) between Box and Inverter (6.56 ft/200.00 cm)	1
C	Charging Cable (+) between Box and Battery Module (3.28 ft/100.00 cm)	2
D	Charging Cable (-) between Box and Battery Module (3.28 ft/100.00 cm)	2
E	Rs485 Communication Cable (3.28 ft/100.00 cm)	2
F	BMS Communication Cable (6.56 ft/200.00 cm)	1
G	Series-connected plug	2
H	Rotation Wrench	1
I	Expansion tube	2
J	Expansion screw	2
K	Power cable disassembling tool	1
L	Ring Terminal (for grounding)	1
M	M5 Screw (for grounding)	1
N	Installation Manual	1
O	Quick Installation Guide	1

4.4.4 Mounting Steps

Wall Mounting:

Step 1: Fix the wall bracket on the wall

- The bracket needs to be removed from the box. Measure it and mark the position of the two holes.
- Drill holes at the depth of at least 3.15 inches/80.00 mm by a drill ( $\varnothing$  0.39 inch/10 mm).
- Install the expansion screw sleeves on the wall, and screw the wall bracket by a wrench (Torque: 1.2-1.5 N·m)

Step 2: Match the box with the wall bracket

- Hang the box over the wall bracket, move the box close to it and match it on the wall bracket

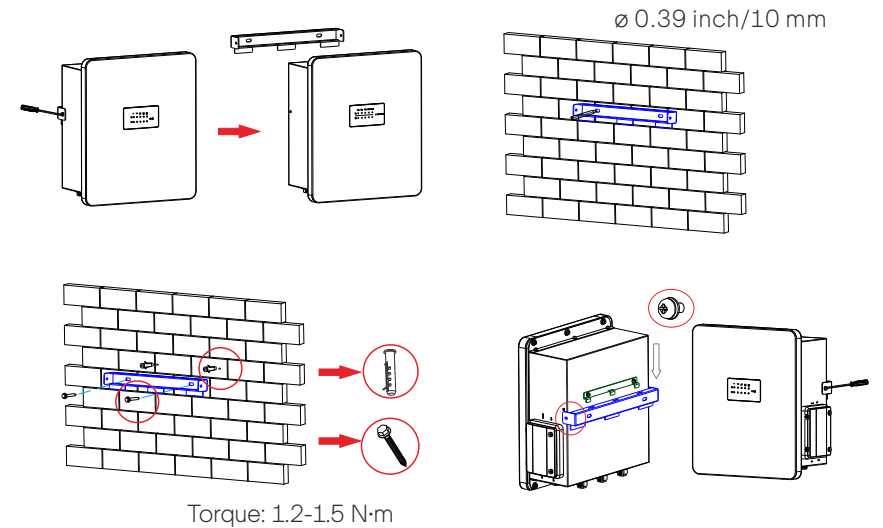

**CAUTION!**  
 Ensure that the system is always exposed to ambient air. The system is cooled by natural convection. If the system is entirely or partially covered or shielded, it may cause the system to stop operating.

## 4.5 Overall Installation

According to the number of batteries, there are two ways of installation alternative for users, with details as follows:

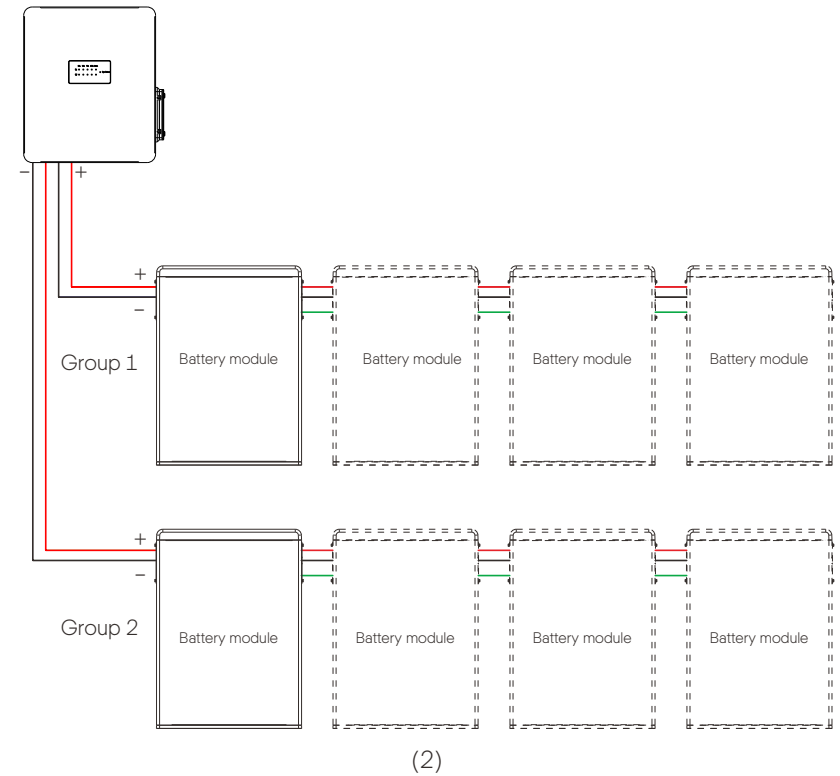
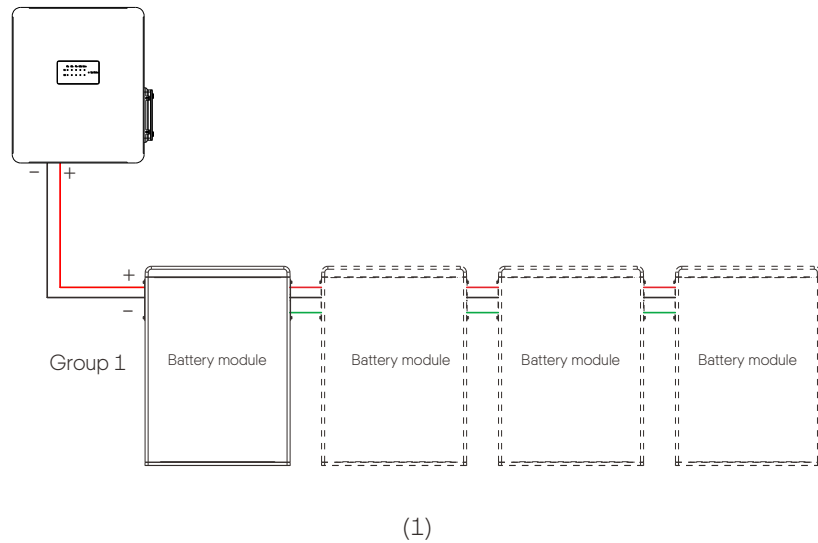

The recommended installation distance between the box and the battery group (incl. group 1 and group 2) is 11.81-23.62 inches/300-600 mm, and the distance between the modules is 9.84 inches/250.00 mm.

**⚠ Caution!**

If both groups of batteries are connected, the number of batteries in these both groups must be the same.

**👉 Note!**

Before installation, please make sure that the wall can bear the weight of the batteries installed. If not, please take the mode of floor installation.

4.6 Cable Connection

It is recommended to protect the cables by using corrugated pipe.

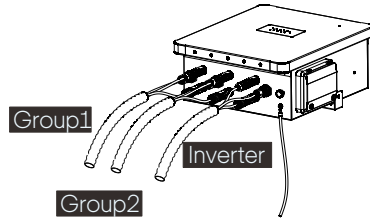

4.6.1 Connecting Cables to Inverter:

Box to Inverter:  
 BAT+ to BAT+;  
 BAT- to BAT-;  
 BMS to BMS

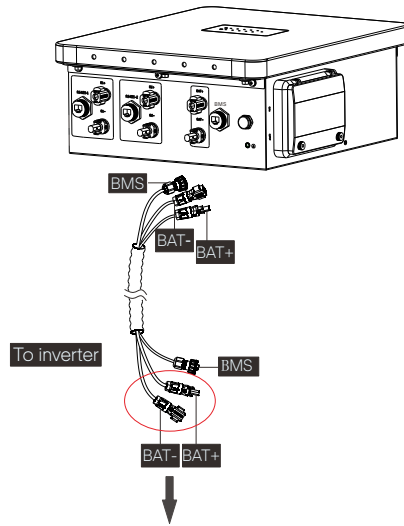

Step1. Strip the cable to 0.59 in/15 mm.

Step2. Insert the stripped cable up to the stop (negative cable for DC plug(-) and positive cable for DC socket(+) are live). Hold the housing on the screw connection.

Step3. Press down the spring clamp until it clicks audibly into place (You should be able to see the fine wire strands in the chamber)

Step4. Tighten the screw connection(tightening torque: 2.0±0.2 N·m)

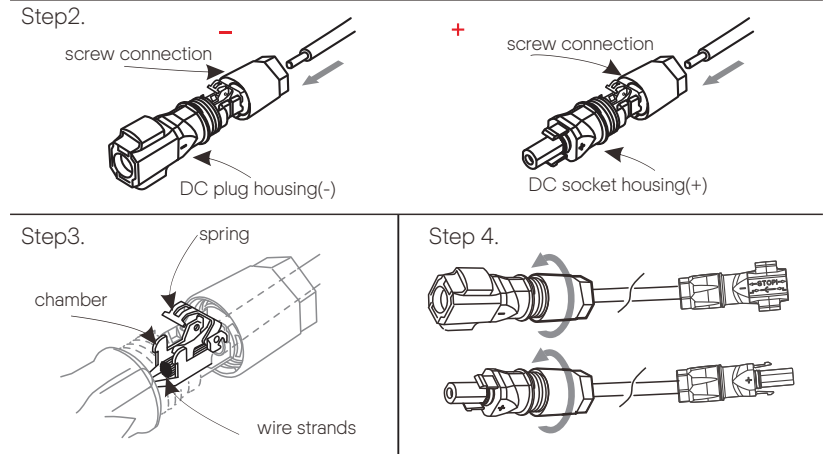

• Connecting the BMS Communication Cable

It is required for the BMS to communicate with the inverter for proper operation. Note that the BMS communication cable is shielded with steel tubes.

The wire order of the communication cable is as follows:

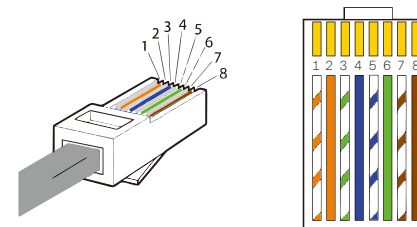

- 1) Orange stripes on white
- 2) Orange
- 3) Green stripes on white
- 4) Blue
- 5) Blue stripes on white
- 6) Green
- 7) Brown stripes on white
- 8) Brown

Sequence	1	2	3	4	5	6	7	8
BMS	/	/	/	CAN_H	CAN_L	/	A1	B1

### 4.6.2 Connecting Battery Modules

For the parallel box + 2/4/6/8 battery packs:

Box to the Battery module:

B1+/B2+ to "+";

B1- /B2- to "XPLUG";

RS485-1/RS485-2 to "RS485 I".

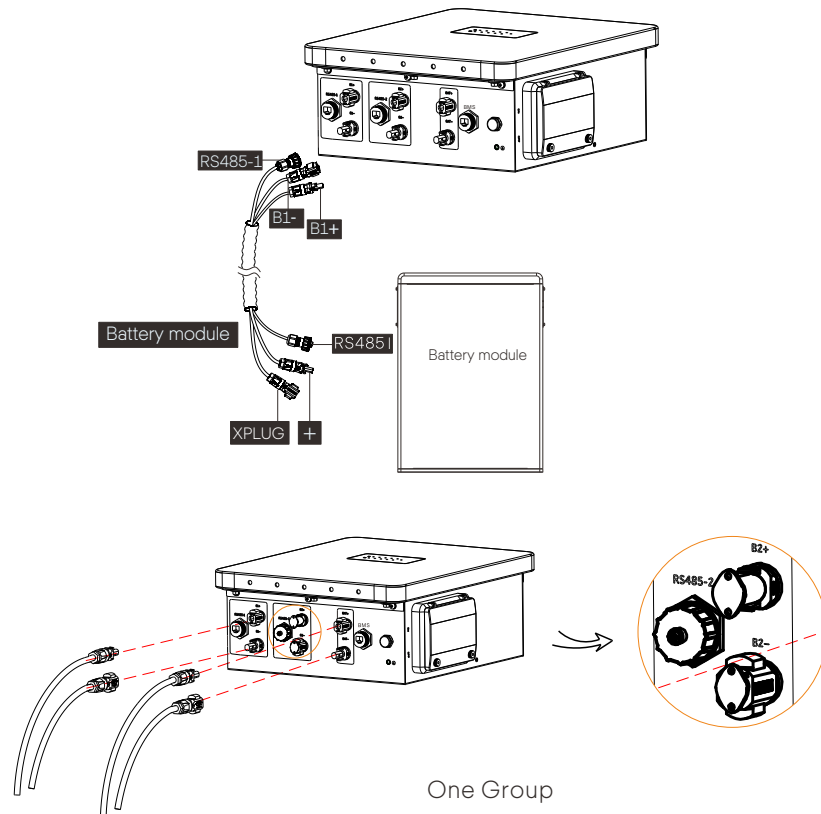

One Group

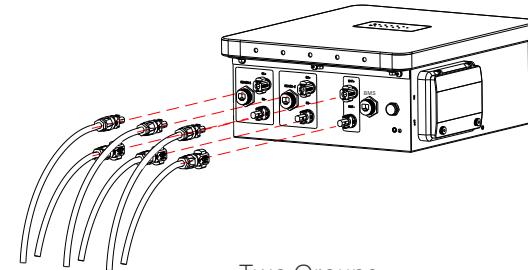

Two Groups

To form a complete circuit, connect "-" and "YPLUG" with series-connected cable on the right side of the last battery module.

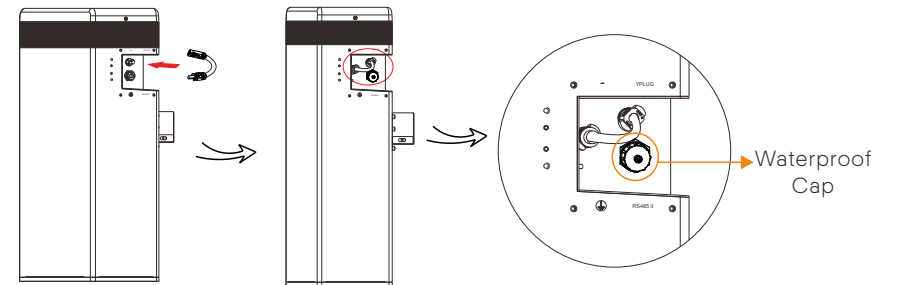

#### Note!

If there is(are) a port(s) that is(are) not wired after wiring is completed, please don't forget to put the waterproof cap(s) on the port(s). See figure above.

### 4.6.3 Connecting RS485 Communication Cable

1) There is a protection cover for the RS485 connector. Unscrew the cover and plug one end of the RS485 communication cable to the RS485 connector. Tighten the plastic screw nut which is set on the cable with a rotation wrench.

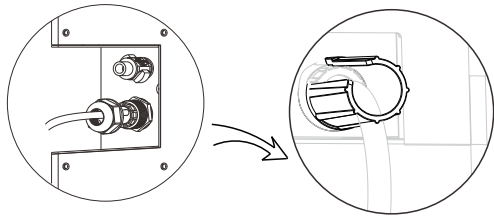

2) Connect the RS485 communication cable from the box to the RS485 I communication port that is on the left side of the battery module.

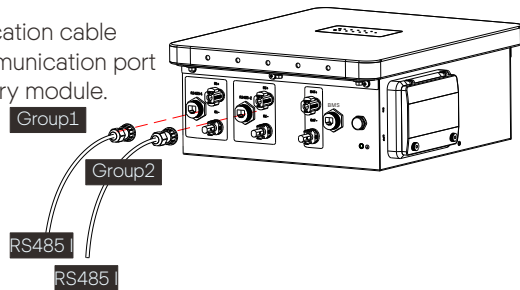

The wire order of the communication cable is as follows:

Sequence	1	2	3	4	5	6	7	8
RS485-1	VCC_485	GND_485	B2	N-	P+	A2	VCC_485_2	GND_485
RS485-2	VCC_485	GND_485	B2	N-	P+	A2	VCC_485_2	GND_485

### 4.6.4 Connecting the Ground Wire

Be sure the ground wire(10 AWG/(4-6) mm<sup>2</sup>) must be connected.

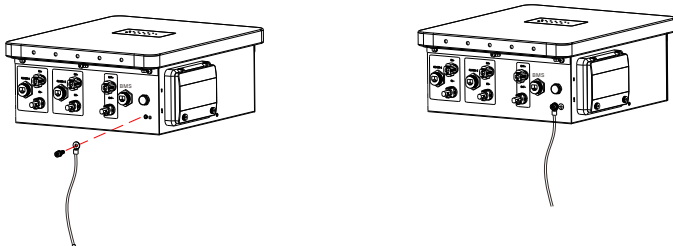

## 5 Commissioning

### 5.1 Configuring the Box

The DIP switch is used to configure the communication between battery module(s) and the inverter. Detailed configuration information is shown as follows:

Configuration activated by inverter:

- 0- Matching a single battery group (group 1 or group 2)
- 1- Matching both battery groups (group 1 and group 2)

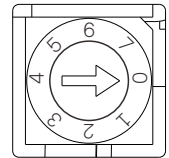

#### ⚠ Caution!

If DIP switch is 1, the number of batteries in these both groups must be the same.

#### 👉 Note!

To adjust the DIP switch, a small flat-head screwdriver shall be prepared by users themselves.

#### Black-start Configuration

The black-start function is only used in an off-grid application and when there is no other power supply.

If the box is started in the black-start mode, even when there is no BMS communication, the port still contains high voltage with risk of electric shock.

If the BMS communication has still not been established within 3 minutes after starting the black-start mode, it indicates that the black start fails to start.

- 4- Matching the Black Start mode for group (group 1 or group 2)
- 5- Matching the Black Start mode for groups (group 1 and group 2)

#### ⚠ NOTE!

When powering on the box, the system will start self-testing. If the buzzer beeps, it means the DIP configuration is in fault or communication failure has occurred. If the buzzer beeps check if the number of battery modules are corresponding to the DIP configuration, and also check if the RS485 communication cables are correctly connected. After checking that these two situations are set, press the POWER button to power on, and press the POWER button again 10 seconds later. In addition, the buzzer will only sound on the corresponding fault during the power-on self-test. After the self-test has already been completed, it will not beep again even if the same fault occurs.

## 5.2 Commissioning

Verify the model number of each battery module to ensure that they are all the same model.

After all battery modules are installed, please follow the following steps to start the box:

- 1) Configure the DIP to the corresponding number according to the number of battery module(s) that has(have) been installed;
- 2) Remove the cover board of the box;
- 3) Move the circuit breaker switch to "ON";
- 4) Press the POWER button to start the box;
- 5) Reinstall the cover board to the box;
- 6) Turn on the inverter AC switch;
- 7) After starting the box, please confirm that the waterproof cap is closed again.

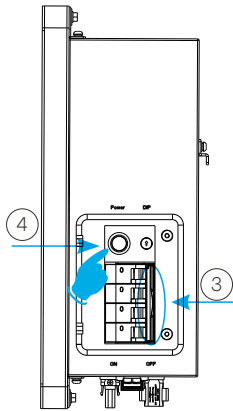

### NOTE!

Frequently pressing the POWER button may cause a system error. Allow at least 10 seconds after pressing the POWER button prior to making another attempt.

## 5.3 Status Indicators

The LED indicators on the front panel of the BMS and the battery modules indicate the operating status.

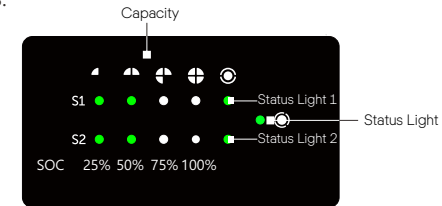

Description of the status indicators of BMS is shown as follows:

No.	Status of BMS	Mode
1	Green LED flashes on 1 sec and off for 4 sec	Inverter sends Idle command
2	In case two groups are in warning state, the status light flashes yellow light for 1 sec and turns off for 4 sec.	Warning
3	(1) In case two groups are in fault, the status light 1 & 2 flash red light for 0.5 sec and turn off for 0.5 sec, and at the same time, the status light comes on solid red light for 10 min, and then flashes red light for 1 sec and turns off for 4 sec until the fault is solved. (2) In case either of groups is in fault, the status light 1 (or 2) flashes red light for 0.5 sec and turns off for 0.5 sec, the status light 2 (or 1) does not light, and the status light comes on green light.	Protection
4	If either of two groups is normal, status light of such group will not light.	Normal
5	Green LED flashes once every 0.3 sec	Upgrade for BMS
6	Light off	Power off

The capacity indicators show the state of charge (SOC):

- When the battery module is neither charging nor discharging, the indicator lights are off.
- When the battery module is charging, a part of the blue LED flashes once every 5 seconds, and a part of the blue LED is on. Take SOC 60% for instance, when in a charging state:
  - 1) The last two blue LED indicators are on
  - 2) The last three blue LED indicators flash once every 5 seconds
- When the battery module is discharging, the blue LED indicators flash once every 5 seconds. Take SOC 60% for instance, when in discharging state:
  - 1) The last three blue LED indicators flash once every 5 seconds

## 5.4 Shutting Down the Box

To shut down the system, follow the steps described below:

- 1) Turn off the breaker between the inverter and the box
- 2) Power off BMS
- 3) Turn off the system by moving the circuit breaker switch to the OFF position
- 4) Ensure that every indicator on the box is off
- 5) Disconnect the cables

## 6 Troubleshooting

Check the indicators on the front to determine the state of the box. A warning state is triggered when a condition, such as voltage or temperature, is beyond design limitations. Box periodically reports its operating state to the inverter. When the box falls outside the prescribed limits, it enters into a warning state. When a warning is reported, the inverter immediately stops its operation. Use the monitoring software on the inverter to identify what caused the warning. The possible warning messages are as follows:

Warning Messages	Description	Troubleshooting
BMS_Internal_Err	1) DIP switch on the wrong position 2) The communication between battery modules is interrupted.	1) Move the DIP switch to the correct position 2) Check if the communication cable between the battery modules is correctly and properly connected.
BMS_OverVoltage	Battery over voltage	Contact your distributor or SolaX directly for servicing.
BMS_LowerVoltage	Battery under voltage	Contact your distributor or SolaX directly for servicing.
BMS_ChargeOCP	Battery charge over current protection	Contact your distributor or SolaX directly for servicing.
BMS_DischargeOCP	Battery discharge over current protection	Contact your distributor or SolaX directly for servicing.

Warning Messages	Description	Troubleshooting
BMS_TemHigh	Battery over temperature	Wait until the temperature of the cells returns to the normal state.
BMS_TemLow	Battery under temperature	Wait until the temperature of the cells returns to the normal state.
BMS_CellImblance	The capacities of cells are different	Contact your distributor or SolaX directly for servicing.
BMS_Hardware_Protect	Battery hardware under protection	Contact your distributor or SolaX directly for servicing.
BMS_Insulation_Fault	Battery insulation fault	Contact your distributor or SolaX directly for servicing.
BMS_VoltSensor_Fault	Battery voltage sensor fault	Contact your distributor or SolaX directly for servicing.
BMS_TempSensor_Fault	Battery temperature sensor fault	Contact your distributor or SolaX directly for servicing.
BMS_CurrSensor_Fault	Battery current sensor fault	Contact your distributor or SolaX directly for servicing.
BMS_Relay_Fault	Battery relay fault	1) Ensure the power cable is correctly and properly connected to the power connector (XPLUG) of the BMS 2) If the first step still does not work, contact your distributor or SolaX directly.
BMS_Type_Unmatch	The type of BMS is unmatched	Contact your distributor or SolaX directly for servicing.
BMS_Ver_Unmatch	The version of BMS is unmatched	Contact your distributor or SolaX directly for servicing.

## 7 Decommissioning

### 7.1 Dismantling the Box

#### Shutting down the box

- Disconnect the cables between the box and inverter
- Disconnect the series wiring terminal on the box
- Disconnect the cables

### 7.2 Packing

Pack the box in the original packaging.

If the original packaging is no longer available, use an equivalent carton or box that meets the following requirements:

- Suitable for loads over 154.32 lbs/69.94 kg
- Properly closed and sealed

## 8 Maintenance

If the ambient temperature for storage is  $-4^{\circ}\text{F}\sim 113^{\circ}\text{F}/-20^{\circ}\text{C}\sim 45^{\circ}\text{C}$ , recharge the batteries at least one time every 3 months.

If the ambient temperature for storage is  $-4^{\circ}\text{F}\sim 68^{\circ}\text{F}/-20^{\circ}\text{C}\sim 20^{\circ}\text{C}$ , recharge the batteries at least one time every 6 months.

**If the batteries have not been used for more than 9 months, these batteries must be charged to at least SOC 50 % each time.**

**For the first installation, the interval among manufacture dates of battery modules shall not exceed 3 months.**

**If one of the batteries is replaced, the SOC of the battery after replacement shall be consistent with those of batteries that have not been replaced, with the maximum difference of between -5% and 5%.**

**If users want to increase their battery system capacity, please ensure that the SOC of the existing system capacity is about 40%. The manufacture date of the new battery shall not exceed 6 months; in case of exceeding 6 months, please charge the new battery to around 40%.**

#### •Maintain periodically

Only qualified person may perform the following works.

During the process of using the box, the manager shall examine and maintain the machine regularly. The concrete operations are as follows.

1) Check that if the cooling fins on the rear of house are covered by dirt, and the machine should be cleaned and absorbed dust when necessary.

This work shall be checked time to time.

2) Check that if the indicators of the box are in normal state, check if the keys of the box are in normal state, check if the display of the system is normal. This check should be performed at least every 6 months.

3) Check that if the input and output wires are damaged or aged. This check should be performed at least every 6 months.

4) Check whether the ground terminal and ground cable are securely connected and all terminals and ports are properly sealed every 12 months

5) You should get the box panels cleaned and their security checked at least every 6 months.



## 9 Warranty

Triple Power protects this product under warranty when it is installed and used as listed in this manual. Violation of the installation procedure or use of the product in any way not described in this manual will immediately void all warranties on the product.

Triple Power does not provide warranty coverage or assume any liability for direct or indirect damages or defects that result from the following causes:

- Force majeure (flooding, lightning strike, overvoltage, fire, thunderstorm, flooding etc.)
- Improper or noncompliant use
- Improper installation, commissioning, start up or operation (contrary to the guidance detailed in the installation manual supplied with each product)
- Inadequate ventilation and circulation resulting in minimized cooling and natural air flow
- Installation in a corrosive environment
- Damage during transportation
- Unauthorized repair attempts
- Failure to adequately maintain the equipment. An on-site inspection by a qualified technician is possible following 120 months of continuous use. Warranty claims made beyond 120 months from date of commissioning may be declined if it cannot be demonstrated that the equipment has been adequately maintained
- External influence including unusual physical or electrical stress (power failure surges, inrush current, etc.)
- Use of an incompatible inverter or devices

# Warranty Registration Form



### For Customer (Compulsory)

Name ..... Country .....

Phone Number ..... Email .....

Address .....

State ..... Zip Code .....

Product Serial Number .....

Date of Commissioning .....

Installation Company Name .....

Installer Name ..... Electrician License No. ....

### For Installer

#### Module ( If Any )

Module Brand .....

Module Size(W) .....

Number of String ..... Number of Panel Per String .....

#### Battery ( If Any )

Battery Type .....

Brand .....

Number of Battery Attached .....

Date of Delivery ..... Signature .....

Please visit our warranty website: <https://www.solaxcloud.com/#/warranty> to complete the online warranty registration or use your mobile phone to scan the QR code to register.

For more detailed warranty terms, please visit SolaX official website: [www.solaxpower.com](http://www.solaxpower.com) to check it.





PLEASE REGISTER THE WARRANTY IMMEDIATELY AFTER INSTALLATION!  
GET YOUR WARRANTY CERTIFICATE FROM SOLAX!  
KEEP YOUR INVERTER ONLINE & WIN SOLAX POINTS!

1

Open your camera app and point your device at the QR code



2

Wait for the camera to recognize the QR code



3

Click banner or notification when it appears on the screen



4

Warranty registration page will be loaded automatically

